

# NICs NETWORK INFORMATION CONNECTION

AN ESSENTIAL SUPPORT RESOURCE FROM THE INSTITUTE FOR NETWORK PROFESSIONALS

## Habit 2: Begin With the End in Mind

### The Habit of Personal Leadership

by Darryl Alder, *Certified 7 Habits Facilitator*

Imagine you are to design and configure a 50-workstation LAN with as much budget as you need. It's a dream come true. Just think, you can start from scratch to lay out the best topology, pull the fastest cable money can buy and make the best server room in the company. With such a task would you ever begin without drawing it out, thinking about it and asking others for their ideas? Surely you would make a plan to make this the best network you could.

Though this situation is hypothetical, it's easy to see how much better any network would be with such a plan. What about yours? You would know what your segments could handle. You might understand why some parts run fast and others slow. With a plan and a little network analysis, you could easily make needed changes. Over time, given enough resources you could even get it just right.



However, this is the real world, and many of us inherited someone else's network infrastructure. We just build as we go, not giving much thought to making the older parts too much better. Until of course, when we add another segment, only to find it was too much for the layout. Then it's back to the 5-4-3 rule or some other troubleshooting help, until we figure out what has gone wrong. Darn if it doesn't go back to that original design. What was that engineer doing anyway? Worse what was you thinking, when you thought you could live with it that way?

Now think about your own life. If someone else stepped into your life, what would they think? Do you have an end in mind for each part of your life? Do you have a clear picture of whom you will be a decade from now? What about the end of this year or next?

Life can be like the network we considered above. It doesn't have to just happen. You can get access to unlimited resources. With those resources and a good blue print for living, your life can run better.

Habit 2 then is beginning with the end in mind. It is the habit that will make things happen. Its focus is mental creation for making a personal development master-plan. When the plan is worked, over time you may get your life just right.

### IN THIS ISSUE

1

Leadership  
Development:  
**Begin With the  
End in Mind**

6

**How to Make  
CAT5 Twisted-  
Pair Network  
Cables**

11

**Home-Based  
Business Needs  
Button-Down  
Approach**

12

Test Prep:  
**Networking  
Technologies**

16

Tips and Tricks:  
**Removing IE**

17

Career Tips:  
**Templates  
Save Time**

## Personal Leadership

When you, or anyone else, practices the habit *Begin With the End in Mind* you are leading yourself. Effective leaders create things first in their minds and then physically create the results imagined. Just as good leaders plan, design and lay out tasks for others to get what they want, this habit engages you in mapping a course for your future so that you will get what you want. You define who you want to be and what you want to do, then lead yourself to that destination.

It is sad that so many people live out their lives with no particular purpose or aim. Their destination is just to make it to the end, or worse, not bother at all, letting each day come as it may. Some catch onto a fad or two and manage certain aspects of their lives well. Others happily follow a leader along the way, but far too few take responsibility for all aspects of living, choosing their courses and directing the outcomes.

If you will take time to define a life course and work toward that destination you will increase the quality of your life. Notwithstanding, there is some work to do first. Let's begin with rescripting.

## Rescripting for Effective Results

Rescripting is a practice of awareness where you examine yourself, then create new and more desirable mental images. Ineffectual thoughts precede ineffective activities and unwanted behavior.

Rescripting a poor thought pattern with more effective ones will direct you toward your positive aspirations.

To do this well, you have to identify your values and develop goals to apply them.

Sound values and goals come from unchanging governing principles. You can replace ineffective patterns of thought and behavior over time with effective ones if you recognize and apply sound principles.

## Principle Center

Before you begin planning all the things you want to be and do in life, there's one thing you should know: You are not in control! Just as there are natural principles like the law of

gravity that govern our physical environment, there are principles that govern human growth and effectiveness. These exist whether we know about them or not. Because principles govern human effectiveness, they impact our ability to produce the results we want and to achieve the things that are most important to us.

### Principle-centered people:

- Stand apart from the emotion of the situation
- Separate themselves from factors that would act on situations
- Make proactive choices after evaluating options

Some people center decisions around work, pleasure, friends, enemies, spouse, self, church, possessions or money. If you have such a focus, you empower circumstance and opinion as your guide. You give control to something or someone outside.

To illustrate, consider Javert in Victor Hugo's *Les Miserables*. He dedicated his whole life to hunting down Jean Valjean. In his mind, a Valjean could not change; once a criminal always a criminal. Finally, in spite of his loathing for the man, he discovered that he was the one short on humanity. Jean Valjean was a changed man and he had spent himself in a faulty cause! Having lost his purpose for living, he took his own life.

Each of us must find the forces that divert us from our real intent. Like Javert, destroying our enemy could leave us no cause to live. Getting a raise, no matter what, may leave us without the friends we'll need later on. Pleasing the boss is nice, but it may conflict with your family or religious values.

It is imperative we each find and hold on to the principles we really care about. For example, Benjamin Franklin devised a system to help himself improve over his lifetime. He found and defined twelve values he felt he wanted in his life. While in this process of discovery, a friend pointed out that he was prideful and should add humility to his list, which he did. He figured that over a year's time he could devote

"One man cannot do right in one department of life whilst he is occupied doing wrong in any other department. Life is one indivisible whole."

*Mahatma Gandhi*

a full week to each of these values and repeat the process four times annually for life. After years of work he felt progress in his original twelve, but that he had made no progress on his humility and that if he had, he would have been proud of it.

That may draw a smile to your face, but consider the lesson. Franklin knew his values and when he added external ones, they made no difference. The quest to find your governing principles is the first step in making a personal mission statement. These may include fairness, integrity, honesty, dignity, service, excellence, capability, improvement, patience, encouragement, equity and trust, to name just a few. But whatever principles you choose, when you use them to make your decisions you will make wiser choices and increase your happiness and well being.

## Mission Statements

Any company worth its salt has a *Mission Statement*, a vision of what they imagine their company to be for the future. It points the direction for a team to follow, to lay the necessary goals to succeed in reaching the objective.

The business world is always attaching itself to the latest “in” topics and buzzwords. In the 1980s everyone was talking about the “paradigm shift.” In the ’90s, companies, large and small, developed company mission statements. Not that they did not have a mission before, but it was usually never published or publicly articulated. A mission statement is a short, descriptive statement of the common objective and focus of the organization.

However, a personal mission statement differs from a group code, in that it is a listing of personal values you already, and most likely always have subscribed to. The problem with a personal mission statement is that since we already live it, it may be somewhat difficult to unmask. Sure, it’s there in front of each of us, but for some reason it is hard to see.

## Personal Mission Statement

Personal mission statements should be concise and focused declarations of purpose. They should give you vision to start something, sort through what you are doing now and begin  
[www.inpnet.org/NICs](http://www.inpnet.org/NICs)

improving other life activities. Your mission is really already part of you and not just some nicely written thoughts about what you might be some day.

Your job is to uncover your mission and capture it in words so that you can be true to it when needed. Over time you will adjust the words or you may find an image or song that captures its meaning better. It’s your mission, so feel free to illustrate it in ways that have deep, personal meaning for you. This is a discovery process and will evolve over time.

Let’s begin the process by developing a *Personal Career Mission Statement*. This will help you in crystalizing your vision of who you are and where you want to go in your career.

Keep your career mission statement limited to no more than three sentences and no more than thirty words. Begin your statement with the words, “My personal career mission is . . .” and finish with qualifying words and phrases to describe your mission. Following are some examples:

“My personal career mission is to become a world-class systems engineer in the banking industry.”

“My personal career mission is to gain experience in the network computing field toward earning at least two operating system certifications.”

“My personal career mission is to master the leading GUI software development tools and gain greater understanding of business applications development.”

Your career mission statement should be tightly focused toward the first three to five years of your career or if you already have

“Creating a Personal Mission Statement will be, without question, one of the most powerful and significant things you will ever do to take leadership of your life. In it you will identify the first, most important roles, relationships, and things in your life—who you want to be, what you want to do, to whom and what you want to give your life, the principles you want to anchor your life to, the legacy you want to leave. All the goals and decisions you will make in the future will be based upon it. It’s like deciding first which wall you want to lean your ladder of life against, and then beginning to climb. It will be a compass—a strong source of guidance amid the stormy seas and pressing, pulling currents of your life.”

*Stephen R. Covey*

FOR A FAST DRAFT MISSION TRY  
<http://www.franklincovey.com/customer/quiz.html>

experience, it could serve as the preamble to your resume—something like:

“I have mastered both the Novell and Microsoft operating systems as shown in both my MCSE and CNE certificaions. To this I have added experience in . . .” (but that’s another article).

This personal career mission statement will form the foundation of your career focus and continued technical education. Don’t just conceive it in your mind. Write it down on paper and put it where you can see it every day. As it needs to be changed or modified, go for it, but keep it sharply focused in your mind.

Now it’s time to start working on a more complete personal mission statement, one that addresses how you will

- **live**
- **love**
- **learn**
- **leave a legacy.**

“I am here to live out loud!”  
*Emile Zola*



Start with a couple of phrases stating what you will be. For instance, your statements might be:

“I will be a loving, listening and available parent to my children.”

“I will be a powerful writer, communicating messages in a manner that inspires change for the better within those who read my words.”

“ I will be true to myself, creating my own opportunities to be happy by seeking out people and groups who share my values.”

“While I know I can’t always choose my situation, I will always choose the way I react to it in a manner that is a positive and responsible example to others.”

“I will live my life as a gift and a great adventure; I will dare to make mistakes; I will reach higher than I think I can; I will spend each day as if it were a pocket full of money, buying only the most precious things with my time.”

Your mission statement should reflect your values and beliefs in a way that guides the goals you will choose to map out your plan. It shouldn’t be a mirror of what someone else thinks you should be, but rather a declaration of yourself.

You make it happen . . . and here’s a place to start. Why not write down the first things that come to mind right now, and email it to yourself? You can come back to it again and again, shaping a mission statement that is a clear reflection of who you are, and who you want to be.

### Steps to Writing Your Personal Mission Statement:

1. As a framework to generate some thoughts about what is important to you, consider and write about these:

a. If you were to die five years from now, how would you want to be remembered by your friends, family, employer/co-workers, and church members? What would you want each of these to say about your character, contributions, and achievements? Write your obituary as if you were each of them.

b. Think of yourself sitting in a rocking chair with your son or daughter. You are about 45 years old and your son or daughter, about 18 years of age, is getting ready to



take off for college many miles away. Your child asks you, “Dad (or Mom), if you could crunch it all down, what are the five values I should live my life by? And why?” Or put another way, “What values should I pass along to my children?”

2. Now make an effort to answer these four questions:

- a. What is your core value?
- b. Why?
- c. What is the source of that value? (parents, clergy, teacher, book, quote, lesson learned, or combinations of these)
- d. How does this core value impact how you will relate to others (i.e., family, co-workers, friends, someone you don’t care for).

A good mission statement will be inspiring, exciting, clear, concise, and engage others. When you feel you have a mission statement ask yourself these questions:

- Is it you?
- Is it true?
- Does it excite you?
- Does it excite others?
- Would you be willing to have your life be about this and only this?

A good mission statement is a single sentence long; it can be understood by a twelve year old; and can be recited by memory at gunpoint. It should be powerful and all encompassing; it should cover your personal life as well as work; it should be big enough to encompass a lifetime of activities For my tastes, shorter is better. Unless you can recite it from memory, it will not likely be a mission. Remember it is very, very hard to build on your weaknesses. It is much easier to build on strengths. Figure out what you do well and work on that first.

Having a personal mission statement can help you make decisions in both your work and your home. Knowing your personal mission statement is the best career insurance you can have, because once you are clear about what you were put here to do, then “jobs” become only a means toward your mission, not an end in themselves.

Having and knowing your personal mission statement can also help you navigate the mercurial world of relationships, where seemingly so few of us can exert much control. Having a personal mission statement has been shown, in fact, to be the one thing that can keep someone alive in settings as brutal and life-threatening as concentration camps.

A personal mission statement acts as both a harness and a sword—harnessing you to what is true about your life, and cutting away all that is false.

Whether we are the migrant worker turning in our last basket of freshly picked fruit, or the CEO who knows that he is only good as his most recent quarterly report, each of us must constantly face two questions: Where now, and what next?

## Summary

Every day we are faced with decisions that lead us either closer or further from our goal. When it comes to goal-making decisions, no tool is as helpful as a personal mission statement. Habit 2, *Begin with the End in Mind*, is about developing a clear picture of where you want to go with your life. It means uncovering your values and setting goals around them. Habit 1 says you are the programmer, not the program. Habit 2 says *you* write the program.

When we finally can write a personal mission statement, new personal powers are unleashed. We see who we are and make changes in things we don’t like. We see who we are and exploit our strengths for greater good in our lives and the lives of others. Because we know our end goal, we are not easily sidetracked by daily living.

*Begin with the End in Mind* means to begin each day or task with a clear understanding of your desired direction and destination. By keeping that end in mind you can make certain that whatever you do on any particular day does not violate the criteria you have defined as supremely important, and that each day of your life contributes in a meaningful way to the vision you have of your life as a whole.



For more information on 7 Habits Training for you or your company contact [Darryl@inpnet.org](mailto:Darryl@inpnet.org) or visit the FranklinCovey Website: [www.franklincovey.com](http://www.franklincovey.com)

“In my own life I found that once I developed a mission statement that was broad enough to cover my interests and activities both on and off ‘the job,’ my life began to make a dramatic shift. Decision making came more easily, because now I had something against which to measure my activities. I learned firsthand the terror and majesty and power of having an exciting mission statement—one that says ‘This is what I am about.’ I began to shed my fears about losing or not having a job, since I knew I would always have my mission, and any job I got would have to be an expression of that.”

Laurie Beth Jones, author  
[Jesus CEO](#)

# How to Make Cat5 Twisted-Pair Network Cables

by Keith Parsons

## Introduction

The purpose of this article is to show you how to make the two kinds of cables, which can be used to network two or more computers together to form local area networks (LANs). These instructions are also the same for making patch cables for networks with more complex infrastructure wiring.

The two most common unshielded twisted-pair (UTP) network standards are the 10 Mhz 10BASE-T Ethernet and the 100Mhz 100BASE-TX Fast Ethernet. The 100BASE-TX standard is quickly becoming the predominant LAN standard. If you are starting from scratch, to build a small home or office network, this is clearly the standard you should choose. The same cables work for both types of Ethernet networks.

## What is a LAN?

A LAN can be as simple as two computers, each having a network interface card (NIC) or network adapter and running network software, connected together with a *crossover* cable.



The next step up would be a network consisting of three or more computers and a hub. Each of the computers is plugged into the hub with a *straight-thru* cable (the crossover function is performed by the hub).

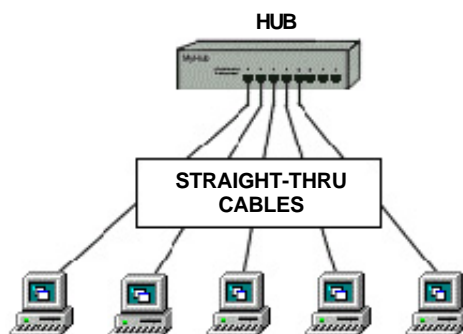

## Network Cable and Connectors

There are several classifications of cable used for twisted-pair networks. I use and recommend only Category 5 (or CAT 5) cable for all new installations. Likewise, there are several fire code classifications for the outer insulation of CAT 5 cable. I use CMR cable, or "riser cable," for most of the wiring I do. You should also be aware of CMP or plenum cable (a plenum is used to distribute air in a building). You may be required by local, state or national codes to use the more expensive plenum-jacketed cable if it runs through suspended ceilings, ducts, or other areas, if they are used to circulate air or act as an air passage from one room to another. If in doubt, use plenum. CMR cable is generally acceptable for all applications not requiring plenum cable.



CAT 5 wire is available in reel-in-box packaging. This is very handy for pulling the wire without putting twists in it. Without this kind of package or a cable

reel stand, pulling wire is a two-person job. Before the advent of the reel-in-box, we used to put a reel of wire on a broom handle to pull it. One person would hold the broom handle and the other would pull and measure the cable. You will produce a tangled mess, if you pull the wire off the end of the reel.

Stranded wire patch cables are often specified for cable segments running from a wall jack to a PC and for patch panels. They are more flexible than solid core wire. However, the rationale for using it is that the constant flexing of patch cables may wear-out solid core cable—break it.

Most of the wiring I do simply connects computers directly to other computers or hubs. Solid core cable is quite suitable for this purpose and for many home and small business networks. I find it also quite acceptable for use as patch cables. You might consider

[www.inpnet.org/NICs](http://www.inpnet.org/NICs)

stranded wire patch cables if you have a notebook computer you are constantly moving around.

CAT 5 cable has four twisted pairs of wire for a total of eight individually insulated wires. Each pair is color coded with one wire having a solid color (blue, orange, green, or brown) twisted around a second wire with a white

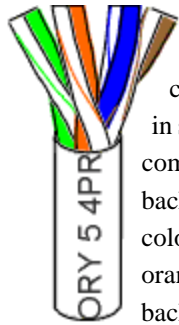

background and a stripe of the same color. The solid colors may have a white stripe in some cables. Cable colors are commonly described using the background color followed by the color of the stripe; e.g., white-orange is a cable with a white background and an orange stripe.

## Connectors

The straight through and cross-over patch cables are terminated with CAT 5 RJ-45 modular plugs. RJ-45 plugs are similar to those you'll see on the end of your telephone cable except they have eight versus four or six contacts on the end of the plug and they are about twice as big. Make sure they are rated for CAT 5 wiring. (RJ means "Registered Jack"). Also, there are RJ-45 plugs designed for both solid core wire and stranded wire. Others are designed specifically for one kind of wire or the other. Be sure you buy plugs appropriate for the wire you are going to use.

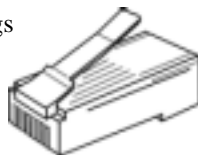

## Network Cable Tools

- **Modular Plug Crimp Tool**

You will need a modular crimp tool. This one is very similar to the one I have been using for many years for all kinds of telephone cable work and it works just fine for Ethernet cables. You don't need a lot of bells and whistles, just a tool that will securely crimp RJ-45 connectors.



- **Diagonal Cutters**

It is easier to use diagonal cutters ("diags" or "dikes") to cut the cable off at the reel and to fine tune the cable ends during

assembly. Also, if you don't have a stripper, you can strip the cable by using a small knife (X-acto, utility, etc.) to carefully slice the outer jacket longitudinally and use the diags to cut it off around the circumference.



- **Cable Tester**

It is much better to test the cables upon completion, than to try each cable on a 'known-good' network. Inexpensive cable testers are available to examine continuity, much more expensive options allow for crosstalk and Cat 5 compatibility.

## A Little Theory

Now, bear with me, you need to understand some of this stuff...

The 10BASE-T and 100BASE-TX Ethernets consist of two transmission lines. Each transmission line is a pair of twisted wires.

One pair receives data signals and the other pair transmits data signals. A balanced line driver or transmitter is at one end of one of these lines and a line receiver is at the other end. A simplified schematic for one of these lines and its transmitter and receiver follow:

Pulses of energy travel down the transmission line near the speed of light (186,000 miles/second). The principal components of one of these pulses of energy are the voltage

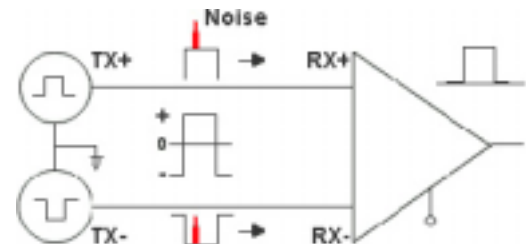

potential between wires and current flowing near the surface of the wires. One concern is the transient magnetic fields which surrounds the wires and the magnetic fields generated externally by the other transmission lines in the cable, other network cables, electric motors, fluorescent lights, telephone and electric lines, lightning, etc. This is known as noise. Magnetic fields induce their own pulses in a transmission line, which may literally override the Ethernet pulses, the conduit of the information being sent down the line.

Twisted-pair Ethernet employs two principle means for combating noise. The first is the use of balanced transmitters and receivers. A signal pulse actually consists of two simultaneous pulses relative to ground: a negative

Check out this course on-line for Patch Cables...

<http://www.perfectpatch.com/webstudy.htm>

pulse on one line and a positive pulse on the other. The receiver detects the total difference between these two pulses. The magnetic field surrounding one wire from a signal pulse is a mirror of the one on the other wire. At a very short distance from the two wires the magnetic fields are opposite and have a tendency to cancel the effect of each other out. This reduces the line's impact on the other pair of wires and the rest of the world.

The second and the primary means of reducing crosstalk—the term crosstalk came from the ability to hear conversations on other lines on your phone—between the pairs in the cable, is the double helix configuration produced by twisting the wires together. This configuration produces symmetrical (identical) noise signals in each wire. Ideally, their difference, as detected at the receiver, is zero.

### Color-Code Standards

Let's start with simple pin-out diagrams of the two types of UTP Ethernet cables. Here are the diagrams:



Note that the TX (transmitter) pins are connected to corresponding RX (receiver) pins, plus to plus and minus to minus. You must use a crossover cable to connect units with identical interfaces. If you use a straight-through cable, one of the two units must, in effect, perform the crossover function.

Two wire color-code standards apply: EIA/TIA 568A and EIA/TIA 568B. The codes are commonly depicted with RJ-45 jacks as follows:

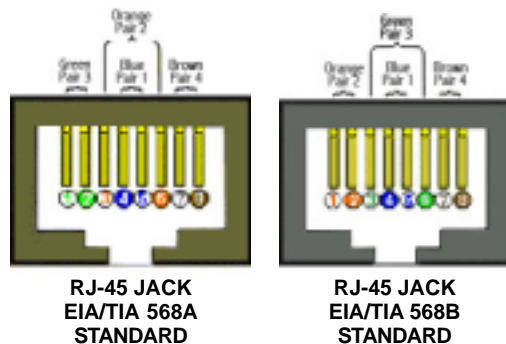

Note that pPins 4, 5, 7, and 8 and the blue and brown pairs are not used in either standard. These pins and wires are not used or required to implement 100BASE-TX duplexing—they are just plain wasted.

Some people use want to 'save' these wasted wires and attempt to use them to carry voice or other data. This is a recipe for network disaster. The additional crosstalk these other signals induce cause the initial network to fail.

You cannot use an flat-untwisted telephone cable for a network cable. Furthermore, you must use a pair of twisted wires to connect a set of transmitter pins to their corresponding receiver pins. You cannot use a wire from one pair and another wire from a different pair.

### Let's Make It Simpler

There are only two unique cable ends in the preceding diagrams. They correspond to the 568A and 568B RJ-45 jacks.

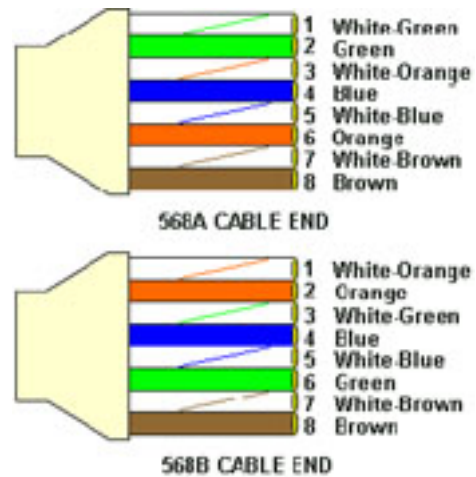

Again, the wires with colored backgrounds may have white stripes and may be donated that way in diagrams found elsewhere. For example, the green wire may be labeled Green-White. The background color is always specified first.

Now, all you need to remember, to properly configure the cables, are the diagrams for the two cable ends and the following rules:

- A straight-thru cable has identical ends
- A crossover cable has different ends

It makes no functional difference which standard you use for a straight-thru cable.



You can start a crossover cable with either standard as long as the other end is the other standard. It makes no functional difference which end is which. Despite what you may have read elsewhere, a 568A patch cable will work in a network with 568B wiring and 568B patch cable will work in a 568A network. The electrons could care less what color cable they are on.

My preference is to use the 568B standard for straight-thru cables and to start crossover cables with a 568B end. That way all I have to remember is the diagram for the 568B end, that a straight-thru cable has two of them, and that the green and orange pairs are swapped at the other end of a crossover cable.

### Let's Make Some Cables

- Pull the cable off the reel to the desired length and cut. The total length of wire segments between a PC and a hub or between two PC's cannot exceed 100 Meters (328 feet or about the length of a football field) for 100BASE-TX and 300 Meters for 10BASE-T.

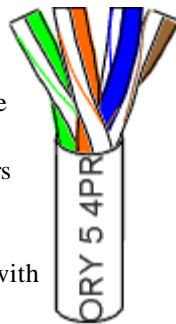

- Strip one end of the cable with the stripper or a knife and diags. Using a knife and diags, carefully slit the cable for about an inch or so and neatly trim around the circumference of the cable with diags to remove the jacket.
- Inspect the wires for nicks. Cut off the end and start over if you see any. Cable diameters and jacket thickness vary.
- Spread and arrange the pairs roughly in the order of the desired cable end.
- Untwist the pairs and arrange the wires in the order of the desired cable end. Flatten the end between your thumb and forefinger. After the ends are in the correct order you can trim the ends of the wires so they are even with one another. It is very important that the unstripped (untwisted) end be slightly less than 1/2" long. If it is longer than 1/2" it will be out-of-spec and

susceptible to crosstalk. If it less than slightly less than 1/2" it will not be properly clinched when RJ-45 plug is crimped on. Flatten again. There should be little or no space between the wires.

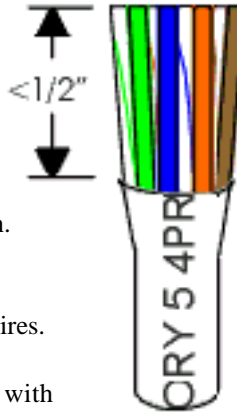

- Hold the RJ-45 plug with the clip facing down or away from you. Push the wire firmly into the plug. Now, inspect the darn thing... before crimping and wasting the plug! Looking through the bottom of the plug, the wire on the far left side will have a white background. The wires should alternate light and dark from left to right. The furthest right wire is brown. The wires should all end evenly at the front of the plug. The jacket should end just about where you see it in the diagram—right on the line. Aren't you glad you didn't crimp the plug?



### All About Crimping

- Hold the wire near the RJ-45 plug with the clip down and firmly push it into the left side of the front of the crimper (it will only



go in one way). Hold the wire in place squeeze the crimper handles quite firmly. The crimper pushes two plungers down on the RJ-45 plug. One forces what amounts to a cleverly designed plastic plug/wedge onto the cable jacket and very firmly clinches it. The other seats

the “pins,” each with two teeth at its end, through the insulation and into the conductors of their respective wires.

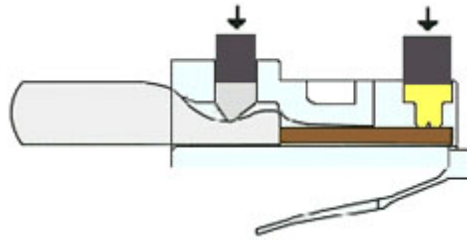

- Test the crimp... If done properly an average person will not be able to pull the plug off the cable with his or her bare hands. And that quite simply, besides lower cost, is the primary advantage of twisted-pair cables over the older thin net, coaxial cables. In fact, I would say the RJ-45 and ease of its installation is the main reason coaxial cable is no longer widely used for small Ethernets. Look at the side of the plug and see if it looks like the diagram and to make sure it is crimped well.
- Prepare the other end of the cable so it has the desired end and crimp.

- If both ends of the cable are within reach, hold them next to each other and with RJ-45 clips facing away. Look through the bottom of the plugs. If the plugs are wired correctly, and they are identical, it is a straight-thru cable. If they are wired correctly and they are different, it is a crossover cable.
- If you have an operational network, test the cable. I normally use a cable tester to confirm continuity on all lines first.
- If the cable doesn't work, inspect the ends again and make sure you have the right cable and that it is plugged into the correct units for the type of cable.

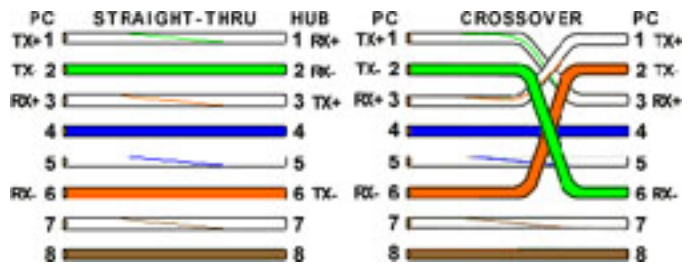

- If you have many straight-thru cables and a crossover cable in your system, you should consider labeling the crossover cable or using a different colored cable for the crossover cable so you don't mix them up.



## CABLING RULES

Try to avoid running cables parallel to power cables.

Do not bend cables to less than four times the diameter of the cable.

If you bundle a group of cables together with cable ties (zip ties), do not over-cinch them. It's okay to snug them together firmly; but don't tighten them so much that you deform the cables.

Keep cables away from devices that may introduce noise into them. Here's a short list:

- electric heaters
- speakers
- printers
- TV sets
- fluorescent lights
- copy machines
- copiers
- welding machines
- microwave ovens
- telephones
- elevator motors
- electric ovens
- dryers, fans
- washing machines
- shop equipment

Avoid stretching UTP cables (the force should not exceed 25 LBS).

Do not run UTP cable outside of a building. It presents a very dangerous lightning hazard!

Do not use a stapler to secure UTP cables. Use telephone wire hangers which are available at most hardware stores.

# Home-Based Business Needs Button-Down Approach

by ReedBooker

There's a whole list of things that owners of home-based businesses don't have to worry about: office dress codes, rigid schedules and where to park are usually near the top. But housebound executives still must deal with some traditional business issues such as insurance.

My informal and unscientific survey indicates that most people starting a business in their homes rely on their homeowners insurance to protect them against unexpected losses. This could be a very costly mistake.

Homeowners insurance policies generally do not respond to business-related insurance needs/protection such as business personal property, general liability, professional liability, business auto liability, and workers' compensation.

People doing business at home have the option in many cases of:

- 1- adding a "business endorsement" to their existing homeowners policy; or
- 2- purchasing a stand-alone business owners package policy. Generally a business office package provides for broader coverage.

The first thing we ask business owners who are considering coverage is for an assessment of their insurable exposures. As examples:

- Is the business set up with its own entrance and dedicated space within the home?
- How many employees work there?
- What is the volume of customer traffic?
- Does the business use especially sophisticated or highly valued equipment?

Other considerations are the value of equipment or data products that are used away from the business, such as laptop computers, remote fax machines, cellular phones and the like. Even credit cards and electronic fund transfers need special attention if they are in the name of the business.

[www.inpnet.org/NICs](http://www.inpnet.org/NICs)

Personal homeowners insurance policies won't normally have detailed coverage for losses of valuable data or papers, the cost to recreate accounts receivable, off-premises risks or other specialized exposures.

Three types of coverage that can only be obtained as part of business policies are:

- **Business Income Protection.** This coverage will replace actual business losses and special expenses that result from a fire, theft or other covered cause.
- **Workers Compensation.** Requirements vary by state, but most require coverage for health care costs and disability income arising from accidental injuries employees sustain at the work site or elsewhere while on duty. This would usually include the external salespeople or consultants representing a homebased business while performing duties elsewhere—even, for example, while taking a client out to dinner during a trade show.
- **Professional Liability.** This may be the most important coverage a business owner can buy—and usually only available as part of a business insurance plan. The cost of defending against claims of liability due to errors or omissions can easily wipe out an unprotected small business. Professional liability policies have become more affordable since the advent of profession-specific premium schedules. In addition to protecting against liability claims, the policies usually provide complete legal defense services.

With all the exposures that any business has, home-based business owners are well advised to consider insurance protection that responds to their business's needs. But they still won't have to worry about what to wear on casual Fridays. ✚

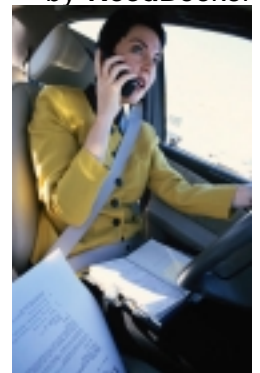

*MIMS International, Ltd. is an insurance broker that has partnered with The Institute for Network Professionals to provide professional liability to our members. For more information call 1-800-899-1399, or e-mail your requests to [mims@mimsintl.com](mailto:mims@mimsintl.com)*

# Networking Technologies

## Exam Prep

by SteveCrowley

### Exam Details

Exam Name: **Networking Technologies**

Exam Number: **50-147**

Number of Questions: **15-25**

Passing Score: **527/800**

Time to take Exam: **30 minutes**

Standard or Adaptive: **Adaptive**

Certifications Exam Counts Toward: **NetWare 5 CNE, CNA**



**This Exam preparation is for the Networking Technologies is for the exam that is adaptive test. You will need TCP/IP for the Newer test.**

### Computing Models

- **Centralized** - Mainframe provides data storage and terminals are used for remote data input/output.
- **Distributed** - Multiple computers individually perform tasks and computations.
- **Collaborative** - Multiple computers share tasks and processing abilities.
- **Local Area Network (LAN)** - Uses one transmission medium; contained within campus.
- **Metropolitan Area Network (MAN)** - Uses different transmission mediums; contained within city.
- **Wide Area Network (WAN)** - Interconnects LANs and MANs and can extend around the world.

### Standard Topologies

- **Bus** - A single cable that connects all computers in a single line.
- **Star** - Computers connect to a centralized hub via cable segments.
- **Ring** - Connects all computers on a single cable. Ends are not terminated, but form a full loop connecting the last computer to the first computer.

- **Mesh** - Commonly used in WAN configurations. Routers are connected to multiple links for redundancy and to give the ability to determine the quickest route to a destination.

### Signal Transmissions

- **Baseband** - Uses digital signaling over a single frequency. Transmits bidirectionally.
- **Broadband** - Uses analog signaling over a range of frequencies. Transmits unidirectional. Uses amplifiers for signal regeneration.
- **Bit Synchronization** - Uses clock to measure time for signals and bit extraction.
- **Asynchronous** - Uses intermittent signals; signals are only processed when data is being transmitted; Data header contains a start bit to tell the device to begin sending/receiving data.
- **Synchronous** - Uses other methods to synchronize device clocks.
- **Guaranteed State Change** - Imbeds clocking signal with data.
- **Separate Clock Signal** - Uses two separate digital or analog signals.
- **Over sampling** - Receiver measures signals faster than the data rate.

### Access Methods

- **CSMA/CD** - Collision Detection; listens to cable prior to sending data. (Ethernet)
- **CSMA/CA** - Collision Avoidance; Announces intention to send data. (AppleTalk)
- **Token Passing** - Token revolves around ring, computer that has token is permitted to data. (Token Ring) One device designated media administrator. Secondary device waits to be polled by primary device to check if it has data to be sent.





## Cables

- **Attenuation** - The degrading of a signal as it travels farther from its origination.
- **Cross talk** - Signal overflow from one wire to another adjacent wire.
- **Jitter** - Instability in a signal wave; Caused by signal interference or an unbalanced FDDI ring or Token Ring.
- **Coaxial** -  
 Thick Ethernet 50 ohm RG-8 and RG-11  
 Thin Ethernet 50 ohm RG-58  
 Cable TV 75 ohm RG-59  
 ARCnet 93 ohm RG-62
- **Unshielded Twisted Pair** - Twisted pair wiring that is susceptible to crosstalk.
- **Shielded Twisted Pair** - Twisted pair wiring that has foil or braided jacket around wiring to help reduce crosstalk and to prevent electromagnetic interference.
- **Fiber-Optic** - Cable in which the center core, a glass cladding composed of varying layers of reflective glass, refracts light back into the core.

Type	Connection Type	Max Length	Speeds	Cost
ThinNet	Coaxial BNC T Connector	185 meters (607 ft)	Up to 10Mbps	Inexpensive
ThickNet	Coaxial DIX/AUI	500 meters (1640 ft)	Up to 10Mbps	Moderately Expensive
UTP	RJ-11, RJ-45, RS-232, RS-449	100 meters (328 ft)	Up to 100Mbps	Moderately Inexpensive
STP	RJ-11, RJ-45, RS-232, RS-449	100 meters (328 ft)	Up to 500Mbps	Moderate
Fiber Optic		25 kilometers	Up to 2Gbps	Expensive

## UTP/STP Category Speeds

- Cat 2 4 mbps
- Cat 3 10 mbps
- Cat 4 16 mbps
- Cat 5 100 mbps

## Data Transmission Devices

Devices that connect one system to another system:

- Transmission media connector: Network interface card, Modem
- Devices that connect network segments to form one large network: Repeater, Hub, Bridge, Multiplexer

## Component Function

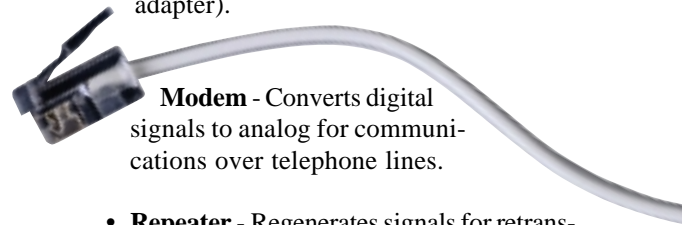

- **Transmission** - Media Adapter Adapter used to connect dissimilar NIC and cable connections (i.e. RJ-45 to RS-232 adapter).

**Modem** - Converts digital signals to analog for communications over telephone lines.

- **Repeater** - Regenerates signals for retransmission. Moves a packet from one physical media to another. Will pass broadcast storms. Cannot connect different network topologies or access methods.
- **Bridge** - Bridges are used to segment networks. They forward packets based on address of destination node. Uses RAM to build a routing table based on hardware addresses. Will connect dissimilar network topologies. Will forward all protocols. Regenerates the signal at the packet level.
- **Remote Bridge** - Same as bridge, but used for telephone communications. Uses STA (Spanning Tree Algorithm).
- **Router** - Routes packets across multiple networks. Uses RAM to build a routing table based on network addresses (i.e. TCP address). Shares status and routing information to other routers to provide better traffic management and bypass slow connections. Will not pass broadcast traffic. Are slower than bridges due to complex functions. Strips off Data Link Layer source and destination addresses and then recreates them for packets. Routers can accommodate multiple active paths between LAN segments. Will not pass unroutable protocols.

- **Brouter** - Will act as a router for specified protocols and as a bridge for other specified protocols.

- **Gateway** - Used for communications between different NOS's (i.e. Windows NT and IBM SNA). Takes the packet, strips off the old protocol and repackages it for the receiving network.

- **Multiplexer** - Device that can divide transmissions into two or more channels.
- **Switches** - Hub with bridging capabilities. Switch filters traffic through MAC addresses. Creates sessions on ports within the hub.

- **Hubs** - Point of connection between segments.
- **Passive Hub** - Connects segments but does not perform signal regeneration. All segments receive signals from all computers.
- **Active Hub** - Connects segments and performs signal regeneration. All segments receive signals from all computers.
- **Switching Hub** - Connects segments and performs signal regeneration. Separate segments are only used when signals are directed towards a specific system on that segment.

connecting systems. LLC - (802.2)  
 Manages link control and defines SAP's (Service Access Points). MAC - (802.3, 802.4, 802.5, 802.12) Communicates with adapter card.

- **Physical Layer** Transmits data over a physical medium. Defines cables, cards, and physical aspects.

### OSI Model OSI Layers

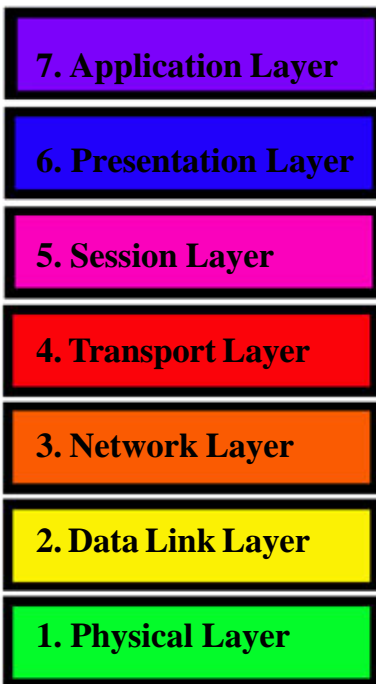

- **Application Layer** - Allows applications to use the network. Handles network access, flow control and error recovery.
- **Presentation Layer** - Translates data into a form usable by the application layer. The redirector operates here. Responsible for protocol conversion, translating and encrypting data, and managing data compression.
- **Session Layer** - Allows applications on connecting systems to establish a session. Provides synchronization between communicating computers.
- **Transport Layer** - Responsible for packet handling. Ensures error-free delivery. Repackages messages, divides messages into smaller packets, and handles error handling.
- **Network Layer** - Translates system names into addresses. Responsible for addressing, determining routes for sending, managing network traffic problems, packet switching, routing, data congestion, and reassembling data.
- **Data Link Layer** - Sends data from network layer to physical layer. Manages physical layer communications between

Protocols	
OSI layer	Protocols residing here
Application	SMB, NCP
Presentation	NCP
Session	
Transport	TCP, SPX, UDP, NetBEUI
Network	IP, IPX, NetBEUI, DLC, DecNET
Data Link	HDLC
Physical	None

### Component: Which OSI Layer It Resides On

- Repeater works at the Physical
- Bridge works at the Data Link (MAC Sublayer)
- Remote Bridge works at the Data Link (MAC Sublayer)

IPX	Performs addressing and routing functions. Resides in Network Layer.
SPX	Extension of IPX. Resides on Transport Layer --ensures error-free packet delivery.
NCP	NetWare Core Protocol; Used for NetWare application, file and print services.
SAP	Service Advertising Protocol; Used by NetWare servers to broadcast status communications.
RIP	Routing Information Protocol; Routers use this to communicate with each other to determine the least busy and shortest (number of hops) network routes.
IP	Performs addressing and routing functions. Resides in Network Layer.
ICMP	Internet Control Message Protocol; Provides error and flow control information for IP.
TCP	Transport service, ensures error-free packet delivery.
UDP	Connectionless transport service.
ARP	Relates network addresses to hardware addresses.

- Router works at the Network layer.
- Brouter works at the Data Link and Network layer.
- Gateway works at the Transport, Session, Presentation and Application layer.
- Multiplexer works at the Physical layer.
- Switch works at the Data Link layer.
- **Frame Relay** - Point-to-point system that uses digital leased lines. Will provide bandwidth as needed. Requires frame relay capable bridge or router for transmission.
- **ATM** - Advanced implementation of packet switching. Transmits at speeds of 155Mbps to 622Mbps with capabilities of higher speeds. Transmits data in 53 byte (48 application, 5 header) cells. Uses switches as multiplexers to permit several computers to simultaneously transmit data on a network. Great for voice and video communications.
- **ISDN** - Transmits at 128k/sec. has three data channels - 2 B channels @ 64k/sec & 1 D channel @ 16k/sec. The B channels carry data while the D channel performs link management and signaling.
- **FDDI** - 100 Mbps token-passing ring network that uses fiber-optic media. Uses a dual-ring topology for redundancy and in case of ring failure. Each ring is capable of connecting 500 computers over 100 kilometers (62 miles). Can be used as a network backbone. Uses beaconing for ring troubleshooting.
- **Beaconing** - Computers are used to detect network faults, and then transmit the fault signal to the server.

NFS	Network File System; Allows dissimilar O/S's to access remote file systems.
HDLC	High-level Data Link Control; Supports asynchronous and synchronous transmissions. Uses LLC flow control.
SLIP	Provides dial-up communications, but is unable to simultaneously transfer multiple protocols.
PPP	Performs dynamic IP addressing, multi-protocol support, password login and error control.

## Packet Switching Networks

Packet Switching - Packets are relayed across network along the best route available.

### Type Function

- **X.25** - Designed to connect remote terminals to mainframe host systems. Is very slow due to constant error checking.



IEEE 802 Specifications	
802.2 LLC (Logical Link Control)	Adds header fields to identify upper-layer protocols.
802.3 CSMA/CD Ethernet	Provides physical layer options including different topologies, media types, data rates and signaling modes.
802.4 Token Bus LAN	Uses bus topology, token-passing access method, and both baseband and broadband medias.
802.5 Token Ring LAN	Uses token-passing access method and differential Manchester encoding to provide data rates.
802.6 MAN (Metropolitan Area Network)	Distributed Queue Dual Bus dynamically allocates bandwidth through time-division access.
802.9 Integrated Voice/Data Networks	Isochronous Ethernet that transports bursty as well as time-sensitive traffic.
802.11 Wireless Networks	Standard for wireless network implementations.
802.12 Demand Priority Access LAN, 100 Base VG	AnyLAN Based on a physical start topology contention-based network.

# Removing IE

## Tips and Tricks

by **Brian Livingston**, *InfoWorld* columnist

In recent months, I haven't written exposes of Microsoft's preposterous legal arguments in the U.S. Department of Justice's antitrust case because Microsoft has been doing such a good job by itself. Everyone is now familiar with the doctored video demonstrations, the "performance comparisons" using dissimilar modems, and so on. You can almost hear Bill Gates saying, "Gee, they ate it up at Comdex."

Much of the trial has revolved around the following Microsoft claims.

- Computer users benefit when Microsoft's contracts require PC makers to ship Internet Explorer (IE) instead of other browsers;
- IE can't physically be removed from Windows 98 anyway;
- If it can be removed, Windows 98 won't run at all; and
- If Windows 98 does run, it will be unacceptably slow.

We now have the opportunity, thanks to an insightful volunteer named Shane Brooks, to see for ourselves whether these claims are true. Brooks, an Australian who is currently studying at the University of Maryland, has developed a Web site that shows you how to remove IE in the comfort of your own office. Brooks cites the following benefits:

- You get back about 35MB of hard disk space;
- Windows 98 runs much faster; and
- Netscape Navigator doesn't crash under Windows 98 anymore. (What a coincidence.)

I've interviewed several people who have followed Brooks' methods and confirm they work under different conditions. The basic steps are as follows:

**Step 1. Use a test system.** Do this on a PC that you can easily reformat and reconfigure if need be after your test.

**Step 2. Replace shell.** On a PC with Windows 98 installed, boot to DOS (hold down Ctrl and select Command Prompt Only). Move explorer.exe from the C:\Windows directory to a

floppy. Move shell32.dll and comdlg32.dll from C:\Windows\System to floppies. Copy the Windows 95 versions of these three files into the correct locations and reboot. At this point, Brooks says you have a smaller, faster Windows shell. You can run IE at any time by switching these three files back. But let's continue to remove IE itself.

**Step 3. Delete folders.** In Windows 98, delete the following folders (including all files they contain) from the C:\Windows folder:

- Catroot
- Cookies
- Downloaded Program Files
- History
- Java
- Temporary Internet Files
- Web

From the C:\Windows\Application Data\Microsoft folder, delete Internet Explorer and Welcome. From the C:\Program Files folder, delete Internet Explorer and Uninstall Information. Search for and delete all Desktop.ini and \*.htt files (used for "Web view" of folders). Finally, if you are the sole user of the PC, delete C:\Windows\All Users.

**Step 4. Delete Favorites.** Exit to DOS and delete the C:\Windows\Favorites folder.

On the downside, you lose the Windows Update feature, but you can get the same thing with any browser at [www.walbeehm.com/win98upd.html](http://www.walbeehm.com/win98upd.html) <<http://www.walbeehm.com/win98upd.html>>. (See below for hyperlinks.) Notepad and WordPad won't work either, but you can copy the Win95 versions if you need these editors.

Brooks' Web site names many other files you can delete, registry entries you can remove, and so forth. And he makes available three free programs that automate a lot of this for you. Go to [www.98lite.net](http://www.98lite.net) <<http://www.98lite.net>> for details.

*Brian Livingston's latest book is Windows 98 Secrets (IDG Books). Send tips to:*

*brian\_livingston@infoworld.com <[mailto:brian\\_livingston@infoworld.com](mailto:brian_livingston@infoworld.com)>. He regrets that he cannot answer individual questions.*



# Templates Save Time

## Career Tips

by **DeniBerger**

How many times have you needed to create a document and had trouble finding the perfect design? Fortunately for us many people have designed templates for our taking. At the end of this article I will list a few sites for you to visit to find those templates that have been designed for our use.

Using templates will shorten your workload from hours to merely minutes. I was given an article that explained how you could save your time by using templates. I have taken some of the information from the article and would like to share it with you.

### The Concept of a Template

As Chuck Green, author of *Desktop Publisher's Idea Book*, 2<sup>nd</sup> edition, says, "The concept behind templates is simple: Modifying an existing document is much quicker than starting one from scratch." Recently I attended a seminar on designing brochures, newsletters, ads, etc and our presenter showed many different ways to make the same document different for each audience you are trying to touch. While a letter that had pictures of

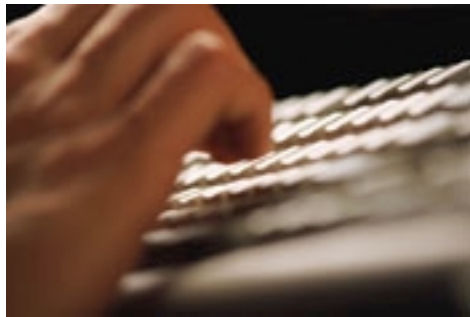

children or toys might touch a children's center, a letter that was more elegant and professional might affect a law firm. No matter what your project, it is important to know that a template may be used for many different types of people."

### 1,2,3...Template

In the article, "Save Time With Templates" (Home Office Computing, Nov. 1998) Chuck Green demonstrates 3 steps to creating your own templates. As with most projects, you need to know what the end result should be. Even if you don't know exactly what you are looking for, you probably have a pretty good idea of an end result. With that in mind, Chuck relates the three steps to creating templates.

#### Step 1: Lay the Foundation.

Many of us have probably seen communities with homes that all look the same. Contractors begin with a simple template of a home or a foundation and begin their work. Purchasers of the homes are able to modify only a few aspects of the home, i.e. carpet, colors, etc.

Much like the contractor, a document designer can lay the same foundation that allows the changing of different aspects of the design. Laying the foundation of your template helps make your end result more stable. If you are working with tables or graphs, be sure to form your grid lines that help line up those types of graphics. You may be designing a newsletter with columns. If that is the case, be sure your template or master page includes columns.

[www.inpnet.org/NICs](http://www.inpnet.org/NICs)

# NICs

## NETWORK INFORMATION CONNECTION

is published by the Institute for Network Professionals

**Prices** Domestic \$100/yr (\$8.50 each)  
Outside US \$125/yr (\$10.00 each)

**Phone** US 801 223 9444  
Fax 801 223 9486

**Address** Please send tips, special requests, change of address, subscriptions, fulfillment questions, requests for group subscriptions, and other correspondence to:

NICs  
1372 South 740 East  
University Office Park  
Orem, UT 84097-8083

or contact us via Internet E-mail at:  
[info@inpnet.org](mailto:info@inpnet.org)

**Postmaster** Periodicals postage paid in Provo, UT.

Postmaster: Send address Changes to:

NICs  
1372 South 740 East  
University Office Park  
Orem, UT 84097-8083

**Copyright** © 1999, Institute for Network Professionals. NICs is an independently produced publication of the Institute for Network Professionals. All rights reserved. Reproduction in whole or in part in any form or medium without express written permission of the Institute for Network Professionals is prohibited. The Institute for Network Professionals reserves the right, with respect to submissions, to revise, republish, and authorize its readers to use the tips submitted for personal and commercial use.

Microsoft, Windows, Windows NT, and MS-DOS are registered trademarks of Microsoft Corporation. NetWare is a registered trademark of Novell, Inc. All other product names or services identified throughout this journal are registered trademarks of their respective companies.

**Staff** Editor-in-Chief **KeithParsons**  
Managing Editor **DarrylAlder**  
Testing Editor **DeniBerger**  
Tech Support Editor **ToddHindmarsh**  
Technical Advisors **ArtAllen**  
**RexMoffitt**  
**SteveCrowley**

**Back Issues** To order back issues, call Customer Relations at 801 223 9444. Back issues cost \$8.50 each, \$10.00 outside the US. You can pay with MasterCard, Visa, or American Express or visit our archive at <http://www.inpnet.org/nics>.

*The Institute for Network Professionals, in alliance with technical suppliers and organizations, makes resources accessible to network professionals worldwide by providing products, training, publications and events.*



1372 SOUTH 740 EAST  
OREM, UT 84097-8083  
801 223 9444-801 223 9486 FAX  
WWW.INPNET.ORG OR INFO@INPNET.ORG



### Step 2: Build a Style Palette

I remember the first time I learned about styles. I was creating a document for one of our classes and couldn't figure out how to have headings and sub-headings without having to change the font, font size, etc. line by line. My frustration level was climbing to higher heights. Then a kind soul showed me the beauty of styles. I was able to work with the document and have my end result much quicker.

Many word processors and desktop publishing programs have the option to build styles. For example, Microsoft Word allows you to specify your own styles, as does Adobe PageMaker. The idea with creating your own styles is to specify how you want your text to look with the click of one button. Once you have created a heading or subheading, all you need to do is highlight the text and click on the particular style you want and your document will conform to that style.

### Step 3: Save It, Use It, Tweak It

Many of the programs we work with allow a template file extension. This feature allows you to save your document as a template. There-

fore, when you re-open the file it actually allows you to make changes to your new document without changing the original settings. When you save your new work, the template is not affected and your new document has a new name.

### Conclusion

Now that you know everything there is to know about templates, you can begin to create your own. However, if you can use other people's work why not right? As I stated earlier I have a list of web sites that have templates that can be used. They are as follows:

- [desktopPublishing.com](http://desktopPublishing.com)  
([desktoppublishing.com/templates.html](http://desktoppublishing.com/templates.html)): Free templates for Adobe Illustrator, Microsoft Publisher, and QuarkXPress
- Microsoft ([www.microsoft.com/works/archives.asp](http://www.microsoft.com/works/archives.asp)): Free templates for Microsoft Works
- Okidata Small Business Resource Center ([www.okidata.com/sbr/html/nf/BusDocs.html](http://www.okidata.com/sbr/html/nf/BusDocs.html)): Free templates for Microsoft Word and Corel WordPerfect.

Hopefully, this information will help you on your journey to creating shortcuts for your work. Good luck. 

### More Tips and Tricks: Quick and Hassle-free Microsoft Software Library Downloads

Here's a trick that I use to quickly find and download files from Microsoft without going through their annoying registration process every time I want something. It's a lot faster as well.

- First use your Web browser or FTP client to go to: <ftp://ftp.microsoft.com/Softlib>
- Download the index.txt file to your local PC. (If you did this from a Web browser then right-click on the file and choose "Save Link As" to put a local copy.)
- Open this file in WordPad or another text editor. Now you can search on the file descriptions. When you find the file you want to download, use this syntax in your Web browser: <ftp://ftp.microsoft.com/Softlib/mslfiles/filename>
- Substitute the name of the file you want for the "filename" portion of the above URL.

Follow this procedure and you'll be spending far less time digging around on Microsoft's Web site and more time doing what you want to do.

